

## EMCGV 32-180

Compression gland, brass



Products may differ in size, colour and appearance to those shown. If you require further information or customisation, please contact us directly.



<b>Material cable gland</b>	Brass nickel-plated
<b>Material sealing gasket</b>	EPDM
<b>Temp. range min</b>	-40 °C
<b>Temp. range max</b>	120 °C
<b>Protection class</b>	IP68 (5 bar 30 min)
<b>Thread type</b>	M
<b>Ø Connection thread D</b>	32
<b>Lead</b>	1,5
<b>Length screw-in thread L</b>	8 mm
<b>Ø cable diameter min</b>	16 mm
<b>Ø cable diameter max</b>	18 mm
<b>Key width SW</b>	36 mm
<b>Collar diameter (E)</b>	39 mm
<b>Total length TL</b>	24 mm - 28,5 mm
<b>Install. torques fitting</b>	20 N/m
<b>Install. torques cap nut</b>	10 N/m
<b>Order no. nickel-plated</b>	10106416
<b>Type</b>	EMCGV 32-180
<b>Packing unit</b>	25
<b>EAN number</b>	4007686021011
<b>Tariff number</b>	74198090
<b>ETIM-Classification</b>	EC000441

Your Contact:

**WISKA UK Ltd.**

Unit 7, Hurling Way · St. Columb Major Business Park · TR9 6SX, St. Columb Major, Cornwall · Great Britain

☎ +44-12-08816062 · 📠 +44-12-08816708

info@wiska.co.uk · www.wiska.co.uk

**Recommended accessories**

**EMMU 32**



10063145

09.01.2025

Your Contact:

**WISKA UK Ltd.**

Unit 7, Hurling Way · St. Columb Major Business Park · TR9 6SX, St. Columb Major, Cornwall · Great Britain

 +44-12-08816062 ·  +44-12-08816708

info@wiska.co.uk · www.wiska.co.uk

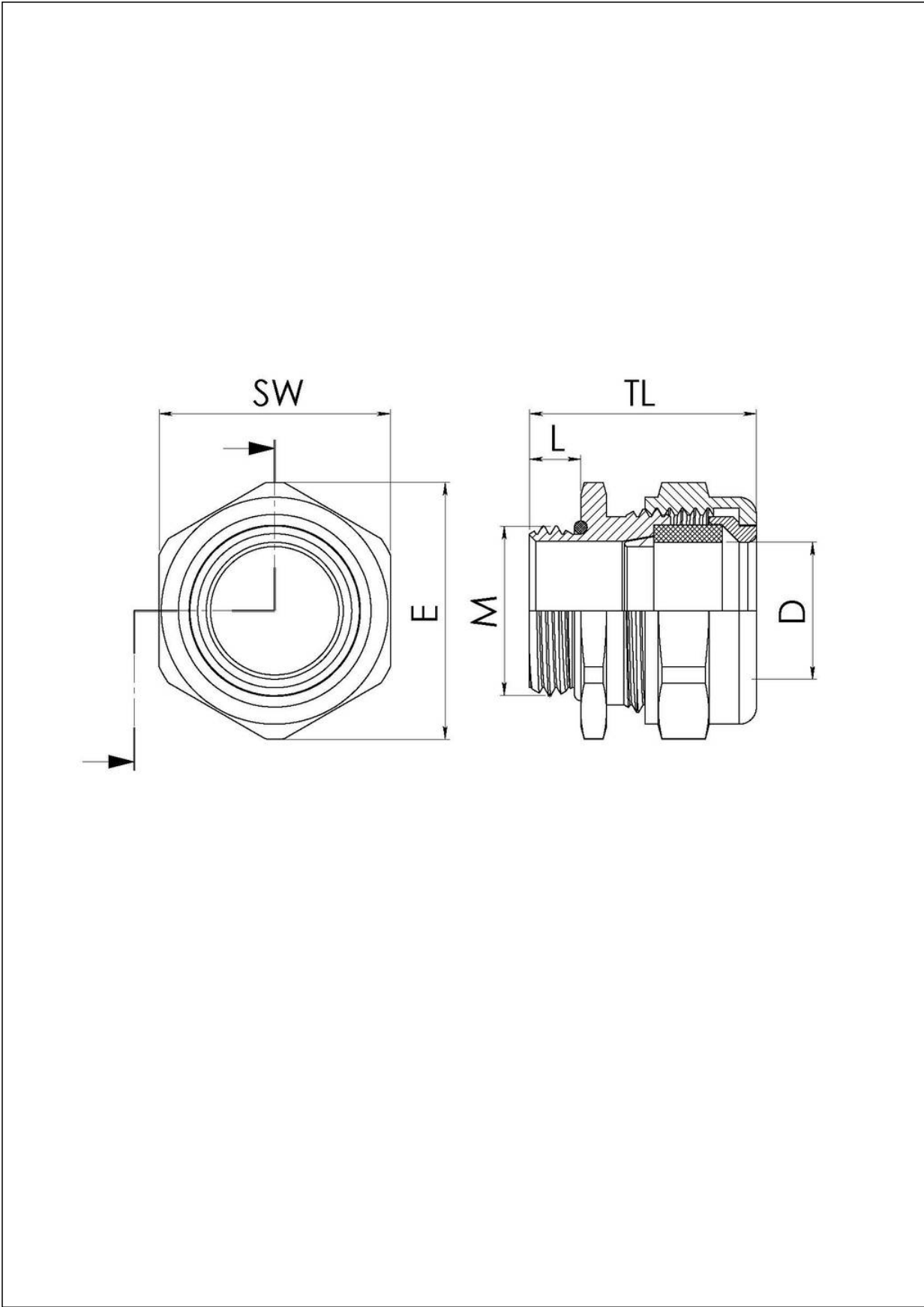

Your Contact:

**WISKA UK Ltd.**

Unit 7, Hurling Way · St. Columb Major Business Park · TR9 6SX, St. Columb Major, Cornwall · Great Britain

☎ +44-12-08816062 · 📠 +44-12-08816708

info@wiska.co.uk · www.wiska.co.uk