

:hager

# EGN200 EGN400

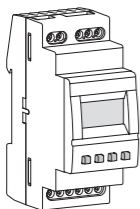

Bluetooth® Multi-Function  
2-Channel Time Switch  
Bluetooth® Multi-Function  
4-Channel Time Switch

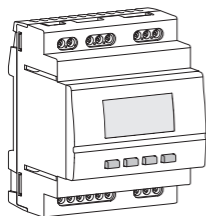

Hager Mood



# Contents

1. About the Product .....	3
2. Main Features.....	4
3. Connection Diagrams.....	6
4. Technical Specifications .....	8
5. Startup.....	11
6. Manual Commands .....	12
7. Reset .....	14
8. Menu .....	15
9. Programs .....	17
9.1. Writing / Editing a Program.....	17
9.2. Disabling a Program .....	23
9.3. Deleting a Program .....	24
9.4. Viewing an Event.....	24
9.5. Editing an Event.....	26
9.6. Deleting an Event.....	27
9.7. Key Lock.....	28
10. Settings .....	29
10.1. BLUETOOTH .....	30
10.2. Date - Time .....	30
10.3. Wire Input.....	31
10.4. Daylight Savings Time .....	34
10.5. Astro .....	38
10.6. Contrast .....	40
10.7. Backlight.....	41
10.8. Language .....	43
10.9. Changing Settings .....	44
10.10. About .....	46
10.11. RF Links .....	47
11. Update.....	50
12. Battery Failure .....	50

## 1. About the product

EGN200 and EGN400 time switches are electronic programming clocks with weekly and annual cycles for automatically controlling different loads.

Examples of applications: street lighting, neon signs, shop windows, monuments, façades etc.

The built-in astronomical clock can be set to switch loads according to sunset and sunrise times. EGN200 and EGN400 switches are also compatible with the Quicklink Hager range of radio products.

An EEN002 / EEN003 twilight sensor (optional) can be connected to switch loads depending on the brightness.

Programming by a mobile device via Bluetooth® wireless technology is recommended using the configuration app (iOS and Android) available for free download.

## 2. Mean Features

- Product delivered with day and time set (from Paris).
- Programming by application via Bluetooth® or local programming (except annual).
- Backlit screen.
- Automatic Daylight Savings Time adjustment.
- Astronomical mode.
- Programming by day or group of days.
- 200 or 400 program steps (depending on version) On, Off, pulses  $\mu$ .
- Constant forcing to On or Off.
- Temporary On or Off variances.
- Variances (temporary, constant or timed) that can be enabled remotely using a push button.
- Bar graph for viewing the daily profile for the 2 or 4 channels (depending on the version).
- Programmable when off only via the screen (with limited functionality).
- Twilight switch function via an EEN002 or EEN003 wired brightness sensor.



When connecting the cell, or before performing any work on it, cut the 230V power supply to the clock.

# Display and keys

## Screen saver

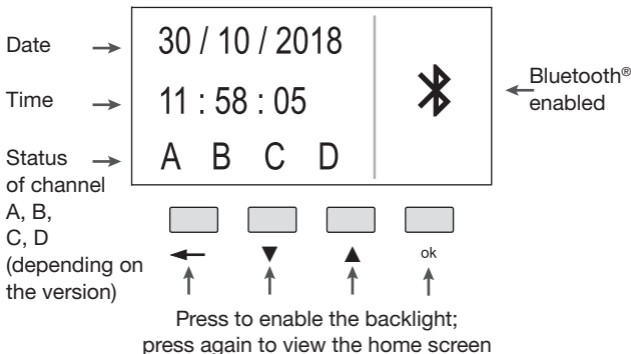

## Home screen

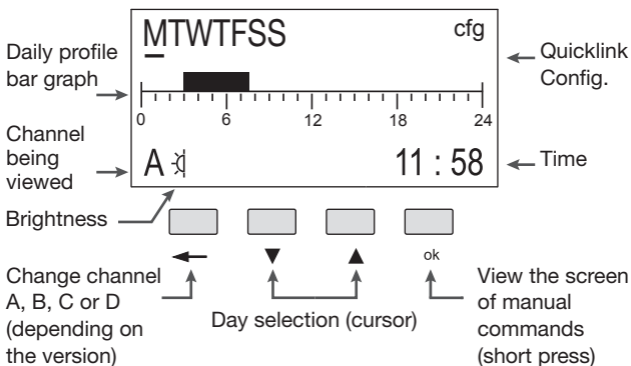
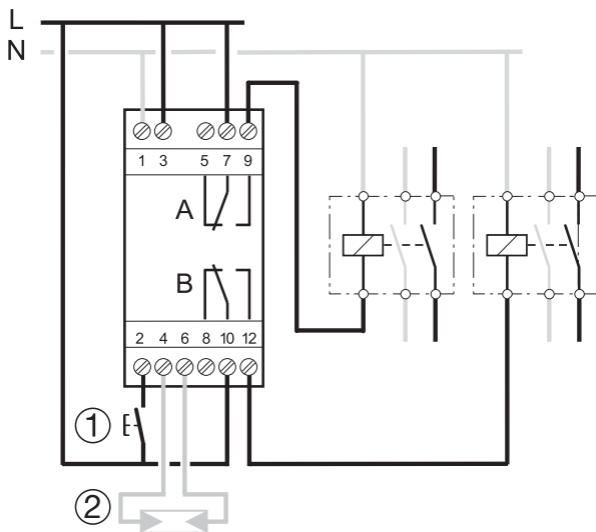

**Image 1:** presentation of screen saver and home screen

### 3. Connection diagrams



Device must only be installed by an electrician according to applicable standards.



① Forcing or variance input

② Brightness sensor

**Image 2:** EGN200 connection diagram (2 outputs)

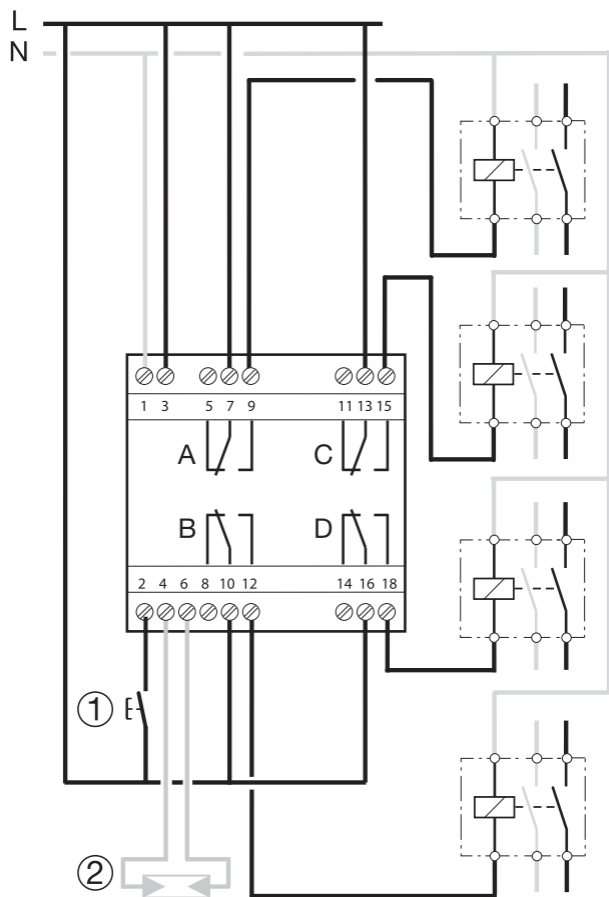

① Forcing or variance input

② Brightness sensor

**Image 3:** EGN400 connection diagram (4 outputs)

## 4. Technical specifications

### Electrical specifications

- Power supply voltage: 230 V~ +10 / -15% and 240 V~ ± 6%
- Network frequency: 50/60 Hz
- Consumption: EGN200 < 350 mW / EGN400 < 500 mW
- Output: 2 or 4 non-insulated changeover contacts (depending on the version) with a voltage measurement of < 1 V for zero-crossing switching.
- Max. break capacity: AC1  $\mu$  16A 230 V~
- Incandescent lamps:
  - Relay power with contact:
    - > normally open / 2300 W
    - > normally closed / 1500 W
- Halogen lamps: 230 V~ 2300 W
- Compensated fluorescent tubes // (max. 45  $\mu$ F):
  - Relay power with contact:
    - > normally open / 400 W
    - > normally closed / 300 W
- Uncompensated fluorescent tubes, compensated in series: 1000 W
- Compact fluorescent lamps and LED lamps:
  - Relay power with contact:
    - > normally open / 400 W
    - > normally closed / 300 W
- Min. break capacity: AC1 100 mA 230 V~
- Rated impulse withstand voltage: 4 kV
- Maximum switching rate at full load: 6 switching cycles / minute



## Functional specifications

- Programming capacity: 200 or 400 steps depending on the model
- Min. time between 2 steps: 1 minute
- Rate accuracy:  $\pm 0.25$  sec / day
- The product switches to standby status (display off): after 1 minute of no power or inactivity. It returns to auto mode as soon as the voltage returns or when a key is pressed.
- Bluetooth® radio frequency: 2.4 - 2.483 GHz
  - Max. emission power: 10 mW
  - Scope: 10 m in free field
  - Version: 4.2
- Mobile device / PC configuration
  - iOS version no earlier than 8
  - Android version no earlier than 5.1
  - Windows version no earlier than 10
  - Bluetooth®: version no earlier than 4.2
- Quicklink radio frequency: 868 - 870 MHz
  - Max. emission power: 25 mW
  - Receiver category 2
  - Scope: 100 m in free field
- Insulation class: 2
- Action type: 2B
- Software class: Class A
- Ball test temperature: 75 °C
- Upstream protection: 16 A circuit breaker
- Declared voltage and current for ECM emission test: 230 V~ - 0.5 A
- Protection rating: IP20 (box), IP30 (box under faceplate)
- Impact resistance: IK04

## Battery

- Power reserve: 10 years without any action
- Non-replaceable and non-rechargeable

## Box

- EGN200 size: 36 mm / 2 modules
- EGN400 size: 72 mm / 4 modules
- Product for surface mounting on DIN rail according to EN 60715

## Environment

- Operating temperature: -5 °C to +45 °C
- Storage temperature: -25 °C to +70 °C
- Relative humidity: 95 % at 20°C
- Pollution level: 2

## Connection by screw terminals

- Rigid 0.2 to 4 mm<sup>2</sup>
- Flexible 0.2 to 2.5 mm<sup>2</sup>
- Screw impression: PH1

## 5. Startup

### With the configuration application

If you are using the app to configure the clock, install as described below.

1. Access the app download link directly by scanning the **QR code** printed on the clock and on the manual with a mobile device.
2. Download and install the configuration app.
3. Check that Bluetooth® is enabled (see Chapter **Settings / BLUETOOTH**).
4. Pair your mobile device and your clock via the Bluetooth® app.
5. Program your product via the app. To do this, use the app to guide you in configuring your clock.

### With the local programming interface

In some cases, the following needs to be set during startup:

- language;
- year, month, day;
- hour and minutes.
- Daylight Savings Time.

Press keys ▲/▼ to configure the required settings on the display.

Press the **ok** key to confirm.

After configuring these settings, the clock switches to automatic mode.

## 6. Manual Commands

From the screen saver, press one of the 4 keys twice to enable the backlight and then switch to the home screen. Press the **ok** key to view the manual commands screen.

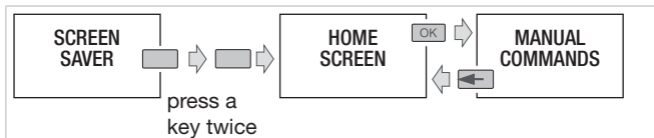

All programming and settings are based on the following principle:

- keys ▲/▼ are used to navigate between outputs A, B, C and D (depending on the version).
- to scroll through the different manual command options for the selected output, the **ok** key is pressed briefly and repeatedly.

Display the output:

- output status ON (black background);
- output status OFF (white background).

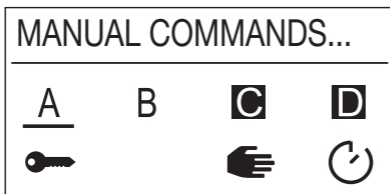

ok

Return to the home screen

Change channel A, B, C or D

Set the option for manual control



**Image 4:** presentation of the manual commands screen.



Press the ← key at any time to return to the home screen.

The manual command options available for each output (A, B, C and D) are:

- ⌚: ON or OFF variance of the output with respect to the current command. The device will return to automatic mode at the next program step.

- : forcing the output to ON or OFF (constant control). The Forcing function is used to force an output into an ON or OFF status. No other command (ON, OFF, timer, pulse or variance) is taken into account if the forcing function is enabled. Only a cancellation of the forcing function or a manual command via the front of the device enables the other commands.
- : manual ON or OFF switching of the output (highest priority command and only available with the buttons on the product).



Priority:

Manual mode > Forcing > Variance

## 7. Reset

It is possible to independently reset the Bluetooth® and **RF link** settings or to **return to the product's factory configuration**.

Reset is accessible via:

- the configuration app;
- locally on the clock; for more information, refer to **Settings / Changing Settings**.

## 8. Menu



If the programming was performed via the configuration app, the local menu does not allow you to edit the period (annual cycle).

From the screen saver, press one of the 4 keys twice to enable the backlight and then switch to the home screen.

Press and hold the **ok** key to view the **Programs / Settings** menu.

All programming and settings are based on the following principle:

- keys ▲/▼ are used to navigate menus and change settings;
- the **ok** key is used to confirm.

Press the ← key at any time to return to the previous choice level.

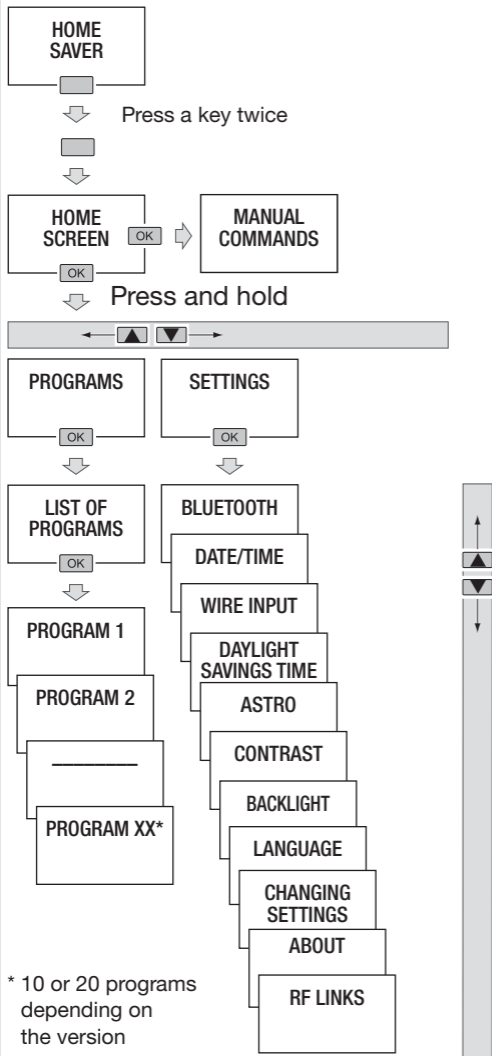

\* 10 or 20 programs depending on the version



## 9. Programs

To access the programs:

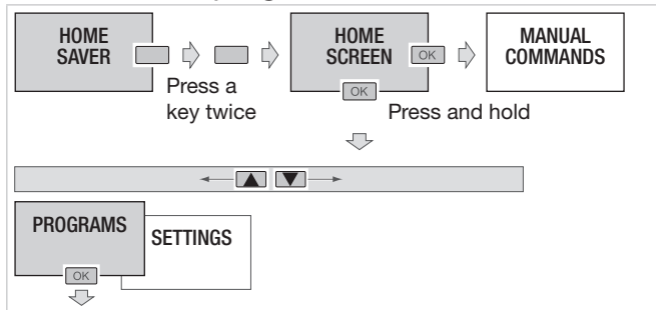

### 9.1. WRITING / EDITING A PROGRAM

It is possible to create up to 10 or 20 programs (depending on the version).

In order to create a program:

- Select the **+ Add** function;
- Edit the program.

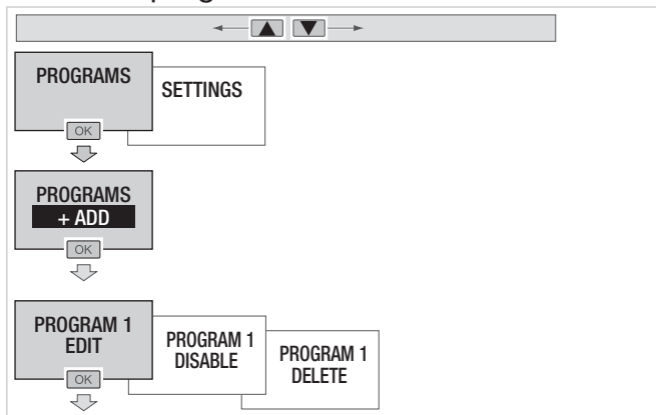

Then define the weekly program.

To do this:

- Program the selection of the output (or outputs) concerned.

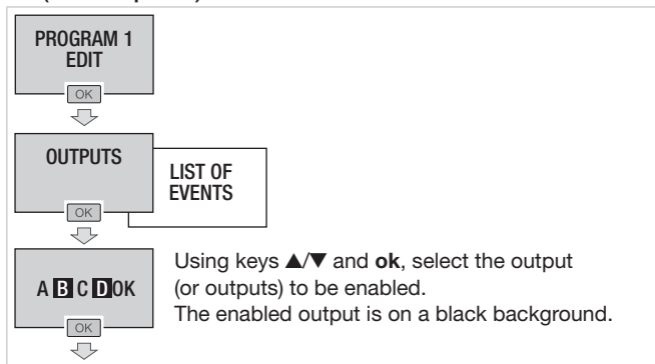

Press the **ok** key after selecting OK to return to the **Edit** menu.

- In the list of events, create the first programming step by selecting **+ Add**. Up to 40 programming steps can be added per program.

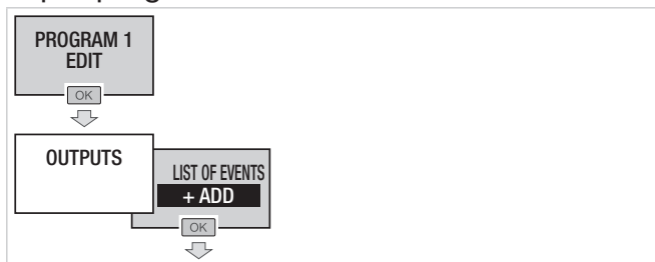

**After selecting a program step, three steps need to be taken to establish the sequence:**

**Step 1.** Define the type of action associated with the program step among the 4 available:

- **ON** to enable the selected output:

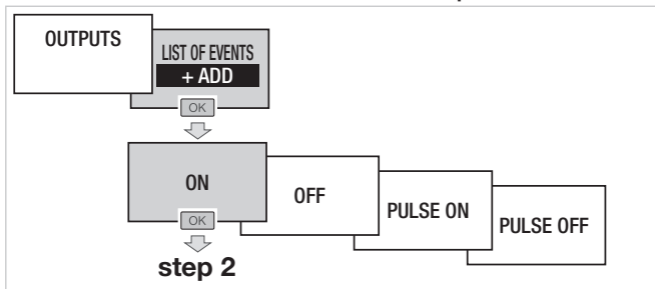

- **OFF** to disable the selected output:

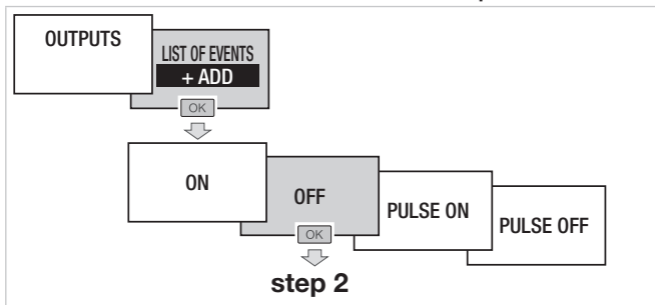

- **PULSE ON** to briefly enable the selected output:

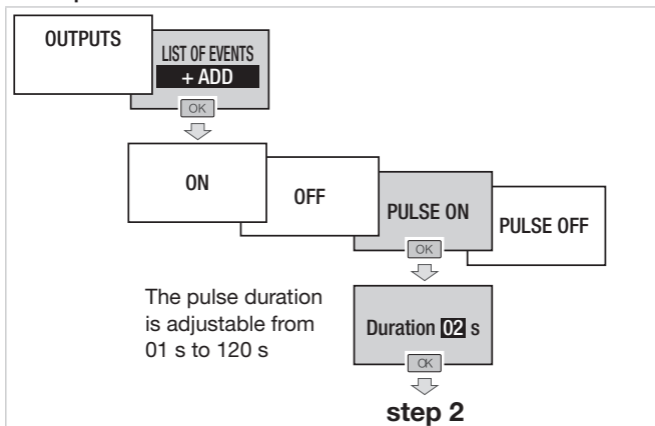

- **PULSE OFF** to briefly disable the selected output:

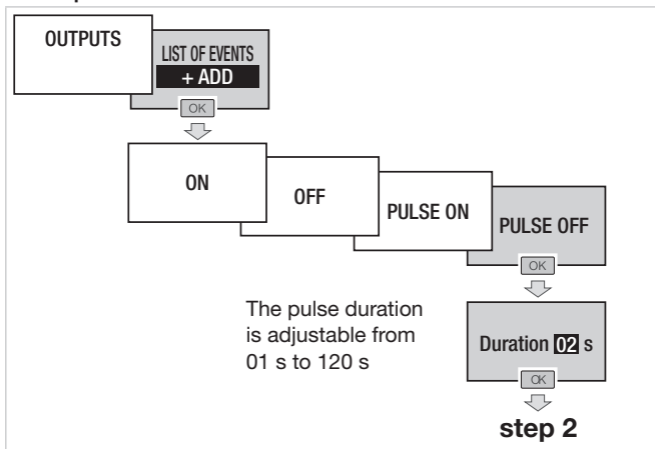

**Step 2.** Define the trigger element associated with the program step among the 4 available:

- **TIME** to start the sequence at a specific time:

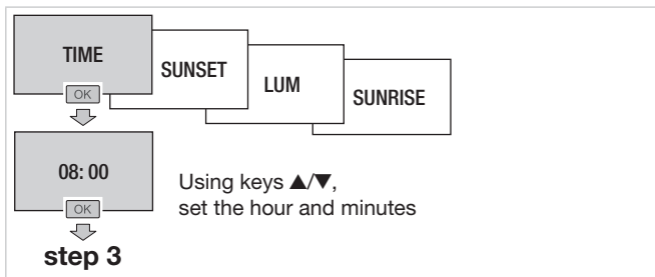

- **SUNSET\*** to start the sequence according to the sunset time:

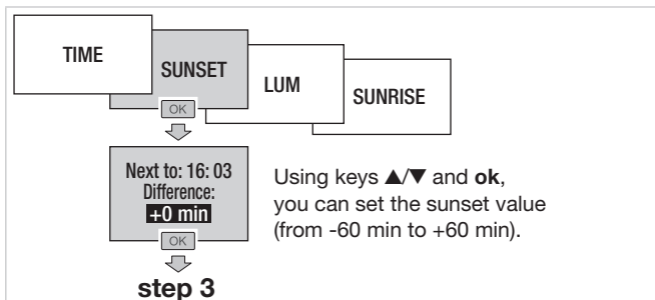

\* Default sunset and sunrise: the sunset and sunrise times correspond to the coordinates (latitude, longitude and time zone) entered in the **Settings / Astro** menu. By default, these coordinates are those of the city of Strasbourg (France) and the clock output is in sequential program mode.

- **LUM** to start the sequence according to brightness. This requires the connection of an EEN002 / EEN003 twilight sensor:

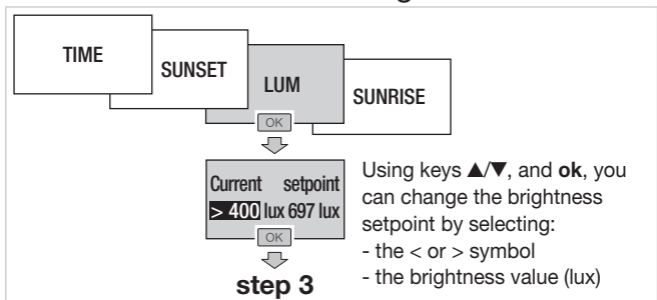

- **SUNRISE\*** to start the sequence according to the sunrise time:

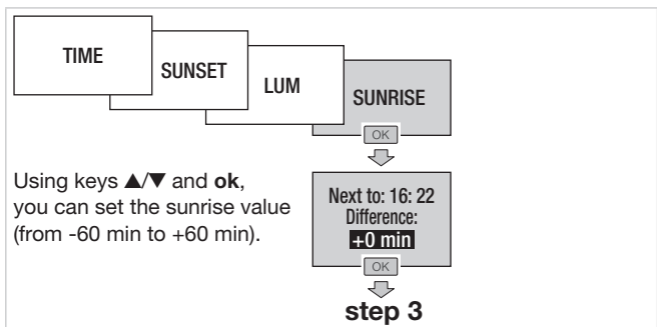

\* Default sunset and sunrise: the sunset and sunrise times correspond to the coordinates (latitude, longitude and time zone) entered in the **Settings / Astro** menu. By default, these coordinates are those of the city of Strasbourg (France) and the clock output is in sequential program mode.

**Step 3.** Select the day (or days) of the week associated with the program step.



Using keys ▲/▼ and **ok**, select the day (or days) of the week to be enabled.  
The enabled day is on a black background.

Press the **ok** key after selecting OK to confirm the weekly programming of the program step and return to the **List of events** menu.



Continue to set your program sequence after sequence; each program has 40 programming steps.

## 9.2. DISABLING A PROGRAM

The **Disable** option is used to disable the entire program.

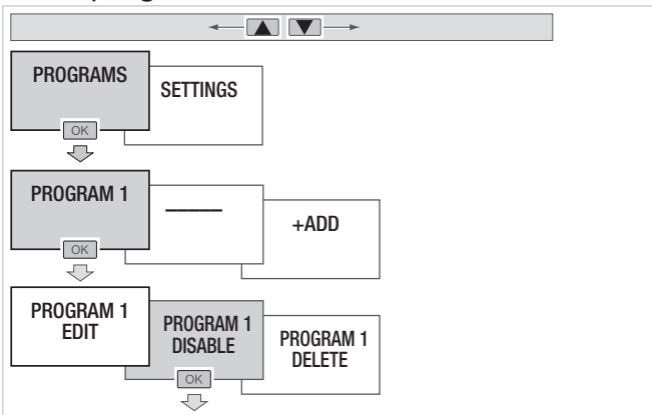



- When a program is disabled, only “Enable” and “Delete” are available for selection.
- After confirming “Enable,” “Edit,” “Disable” and “Delete” will again be available for selection.

### 9.3. DELETING A PROGRAM

The **Delete** option is used to delete the entire program.

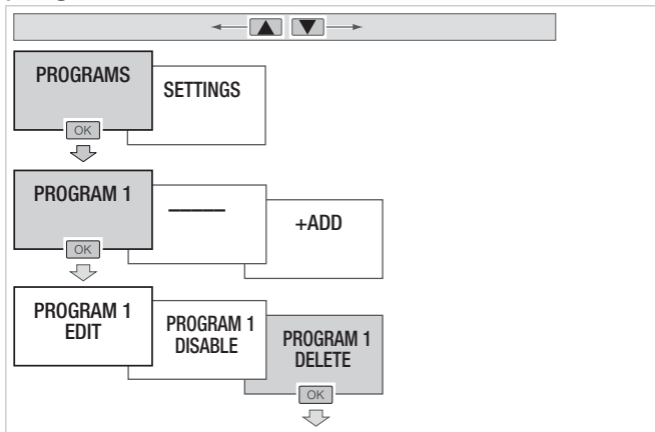

When a program is deleted, the number assigned to that program will be available when creating / adding a new program.

### 9.4. VIEWING AN EVENT

Once a program step is created, the **View** option is available to check the programming of an event:



- the type of action;
- at what time of the day;
- the day (or days) associated with the program step.

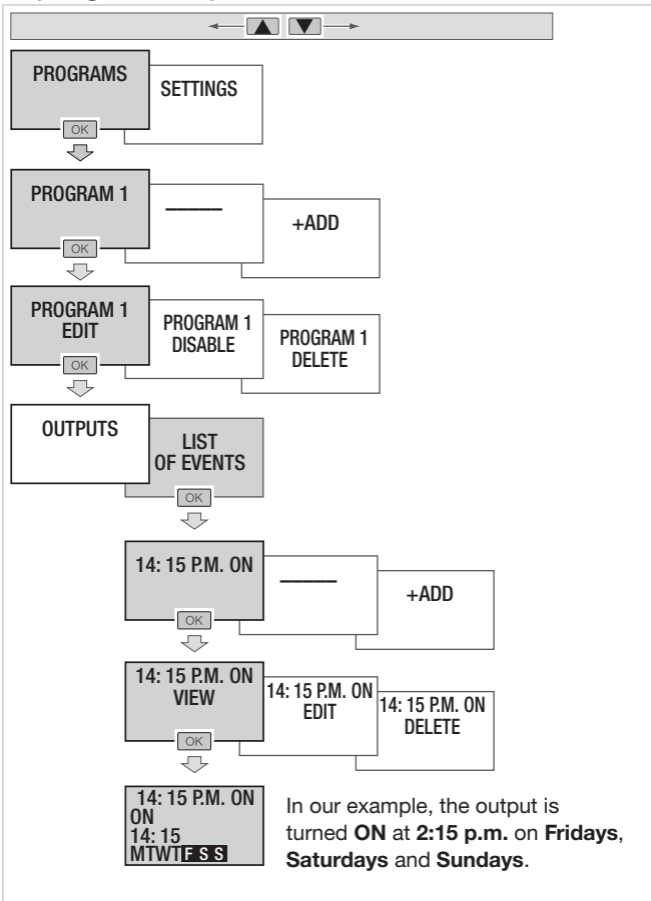

## 9.5. EDITING AN EVENT

Once a program step is created, the **Edit** option is available to change the programming of an event.

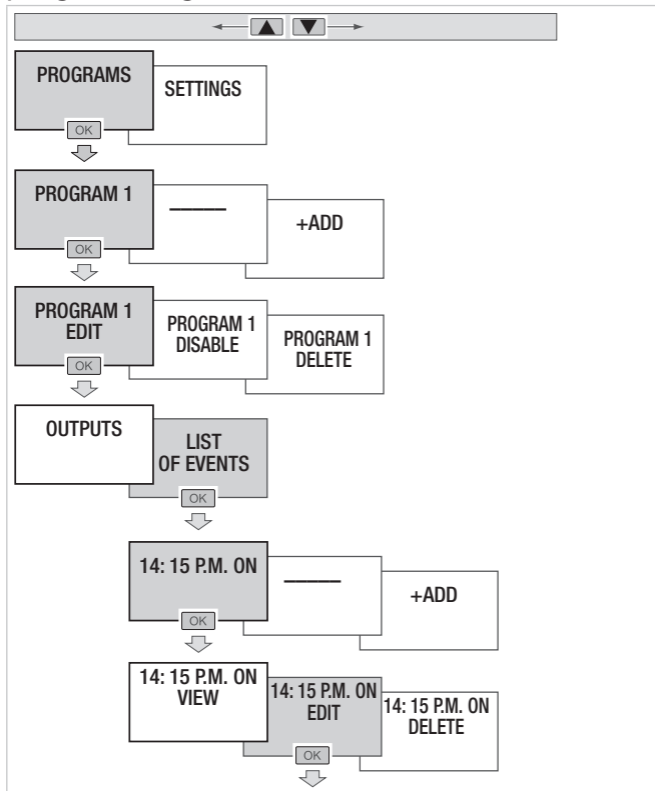

To change an event, repeat steps 1 to 3 of the Chapter “WRITING / EDITING A PROGRAM.”

## 9.6. DELETING AN EVENT

The **Delete** option is used to delete a programming step in a program.

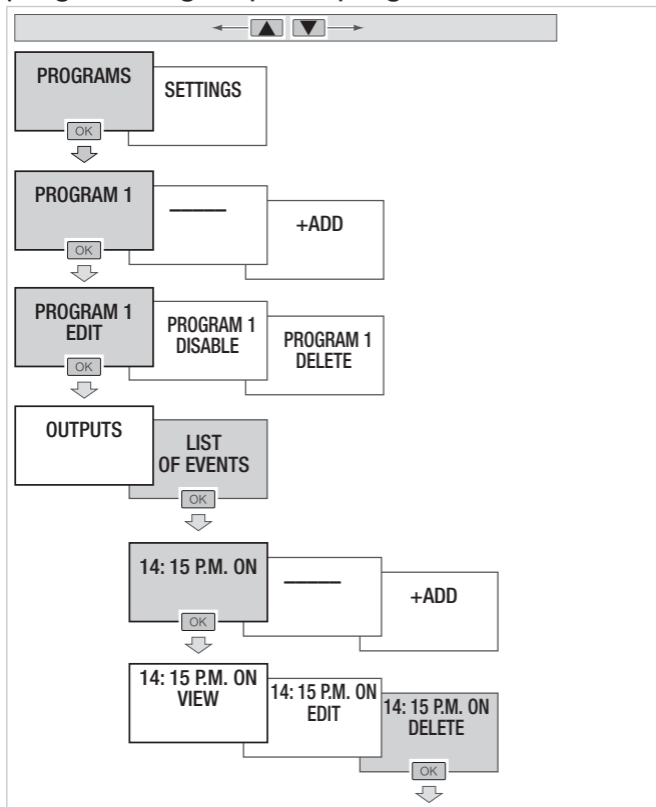

## 9.7. KEY LOCK

This function is used to lock the clock keyboard. It can be accessed via the configuration app or locally using the **ok** and the ← keys.

- To enable this function locally, press the **ok** and ← keys simultaneously (> 3 s) until the  symbol appears (2 s).



The user only accesses the home screen and views the current program and status of the outputs.

- To disable this function locally, press the **ok** and ← keys simultaneously (> 3 s) until the  symbol appears (2 s).



The user can access all screens.

# 10. Settings

To access the settings:

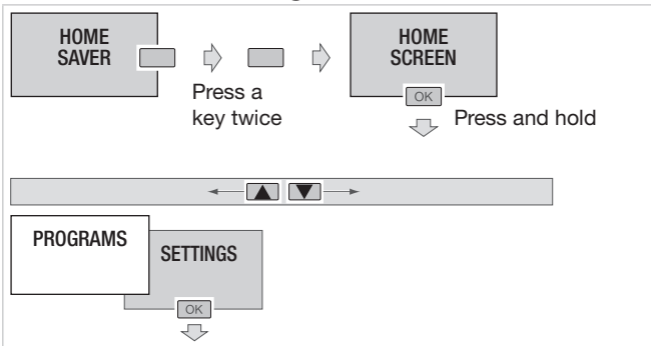

The **Settings** menu provides access to the following settings:

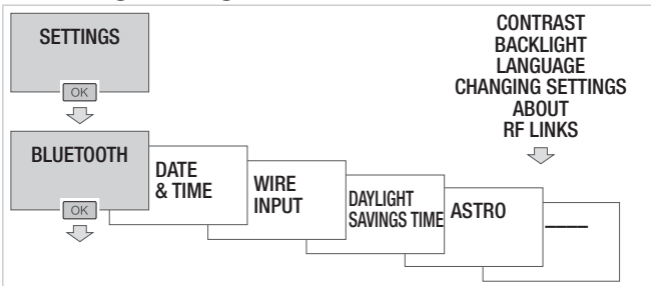

## 10.1. BLUETOOTH

### Enabling Bluetooth®



Enable the Bluetooth® function if you use the configuration app to program your clock.

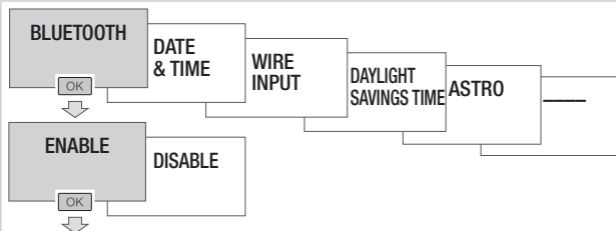

Press **ok** to confirm and the ← key to return to the **Settings** menu.

## 10.2. DATE - TIME

### Setting the time and day

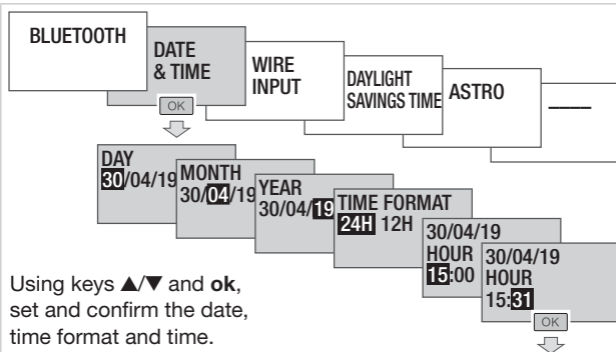

Using keys ▲/▼ and **ok**, set and confirm the date, time format and time.

Press **ok** to confirm and return to the **Settings** menu.

## 10.3. WIRE INPUT

### Variance / forcing input

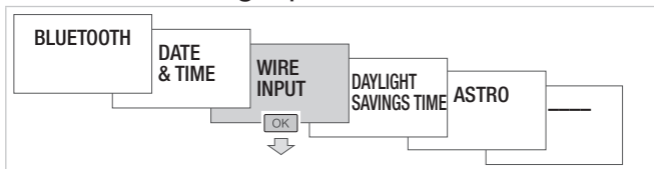

The **Wire Input** menu is used to select:

- The type of product that activates the input (push button or switch)

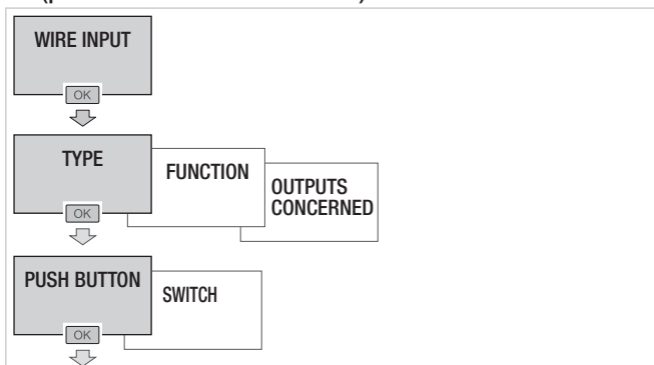

Press **ok** to confirm and return to the **Wire input** menu.

- The associated function if you chose the **Push Button** type:
  - **ON/OFF Switch**: command to enable or disable the output
  - **Contactors**: reverses the output status each time it is pressed.

- **Timer ON:** output enabled for an adjustable time period with preset values from 1 s to 24 h.
- **Timer OFF:** output disabled for an adjustable time period with predefined values from 1 s to 24 h.

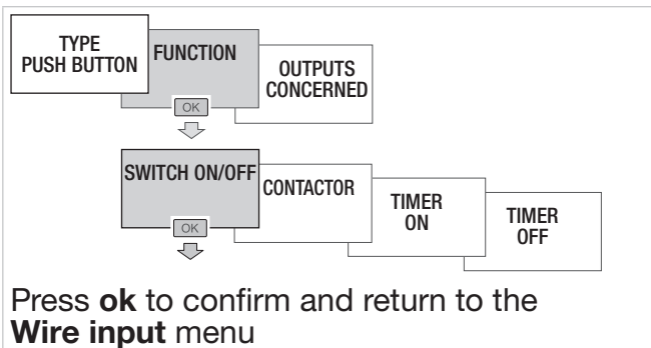

or

- The associated function if you chose the **Switch** type:
  - **ON/OFF Switch:** command for enabling or disabling the output
  - **Forcing ON:** forcing enabling of output
  - **Forcing OFF:** forcing disabling of output.



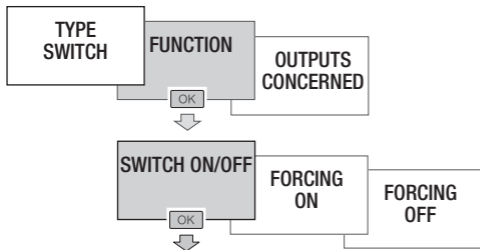

Press **ok** to confirm and return to the **Wire input** menu

- The output (or outputs) concerned by the wire input:

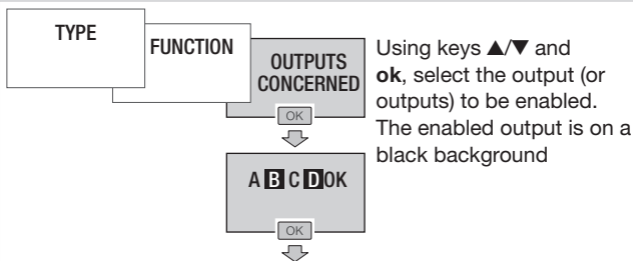

Using keys ▲/▼ and **ok**, select the output (or outputs) to be enabled. The enabled output is on a black background

Press the **ok** key after selecting OK to confirm the submenu and return to the **Wire Input** menu.

## 10.4. DAYLIGHT SAVINGS TIME

This menu allows you to adjust daylight savings dates and times according to the geographical area of the project.

The time change always takes place between 2:00 a.m. and 3:00 a.m.

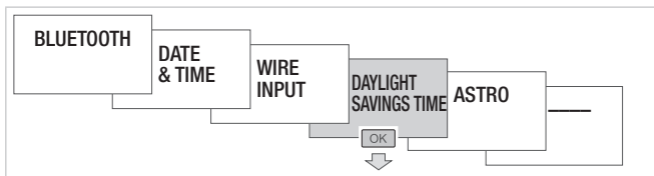

Select the type of DAYLIGHT SAVINGS TIME adjustment, then confirm using the **ok** key.

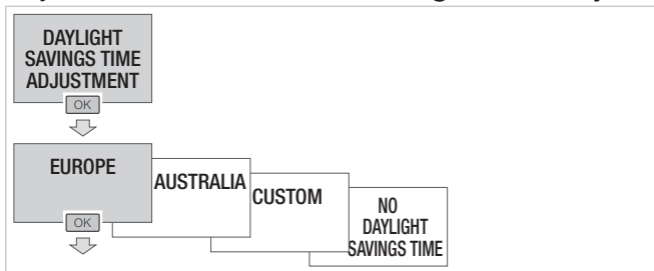

Types available:

Type	Start of Daylight Savings Time	End of Daylight Savings Time	Application area
<b>EURO*</b> <b>DAYLIGHT SAVINGS TIME</b>	last Sunday in March	last Sunday in October	European Union
<b>AUSTRALIA DAYLIGHT SAVINGS TIME</b>	last Sunday in October	last Sunday in April	Australia
<b>CUSTOM DAYLIGHT SAVINGS TIME</b>	freely programmed date	freely programmed date	
<b>NO DAYLIGHT SAVINGS TIME</b>	no change	no change	

\* default type

When the **CUSTOM** type is chosen, you can select:

- the relative dates if the event needs to be repeated every year in the same period.

CUSTOM

OK



RELATIVE DATES

OK

FIXED DATES

Using keys ▲/▼ and **ok**, select the relative dates of the start of the daylight savings time period to be enabled.



START OF DAYLIGHT SAVINGS TIME

**1** Sunday April

OK



END OF DAYLIGHT SAVINGS TIME

**last** Sunday October

OK



The examples opposite (**start of daylight savings time (début de l'été)**: the first Sunday in April and **end of daylight savings time (début de l'hiver)**: the last Sunday of October) are configured as follows:

- possible values for the day: 1, 2, 3, 4 and last;
- day of the week: Monday, Tuesday . . . Sunday;
- month: January, February . . . December.

Press **ok** to confirm and the ← key to return to the **Daylight Savings Time** menu.

- the fixed dates if the event needs to be repeated every year on the same dates.

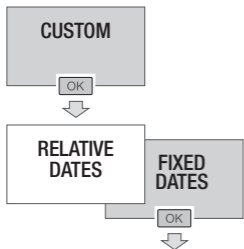

Using keys ▲/▼ and **ok**, select the fixed dates of the start and end of Daylight Savings Time to be enabled.



The examples opposite (the **start of Daylight Savings Time**: 27 February and the **end of Daylight Savings Time**: 23 October) are configured as follows:

- possible values for the day: 01 to 31;
- month: January . . . December.



Press **ok** to confirm and the ← key to return to the **Daylight Savings Time** menu.

## 10.5. ASTRO

The **Astronomical** menu is used to precisely define the geographic location of the project and thus calculate the sunrise and sunset times automatically.

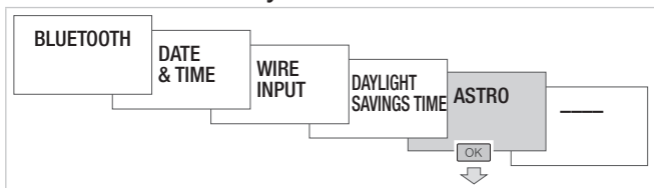

After selecting the **Astro** mode:

- Choose the A, B, C or D output concerned
- Choose the mode of the astronomical program:
  - **Sequential**: the clock works automatically from sunrise and sunset times.
  - **Specific**: the clock works by combining the time periods defined in the program, the sunrise and sunset times and the brightness thresholds.

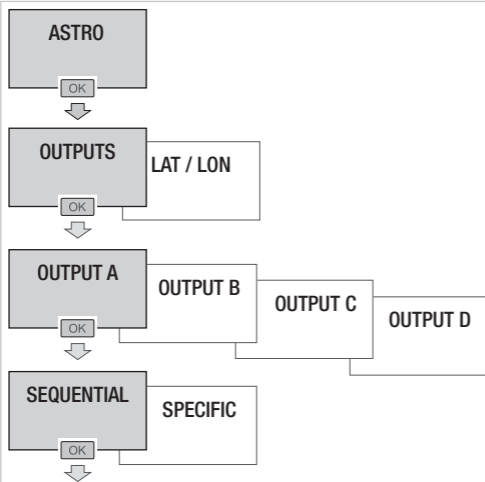

Press **ok** to confirm and the ← key to return to the **Astro** menu.

Fill in the data required for the clock to calculate the sunrise and sunset times automatically.

- Set the latitude of the geographical area of the project
- Set the longitude of the geographical area of the project
- Set the time zone.



In the factory configuration, the latitude, longitude and time zone correspond to the coordinates of the city of Strasbourg (France).

**OUTPUTS**

**LAT / LON**

OK

Lat **48° 35' N**  
Lon **07° 44' E**

OK

**TIME ZONE**  
GMT: **+1.00**

OK

Using keys ▲/▼ and **ok**, set:

- the latitude: the setting range is 90°N (North) to 90°S (South);
- the longitude: the setting range is 180°E (East) to 180°W (West);
- the time zone: the setting range is -12h to +12h with respect to the Greenwich meridian.

Press **ok** to confirm and the ← key to return to the **Astro** menu.

## 10.6. CONTRAST

The **Contrast** menu is used to adjust the white level of the screen.

CONTRAST

BACKLIGHT

LANGUAGE

CHANGING SETTINGS

ABOUT

RF LINKS

OK

70%

OK

Using keys ▲/▼, increase or decrease the contrast (white level) of the screen.

Press **ok** to confirm and return to the **Settings** menu.



## 10.7. BACKLIGHT

The **Backlight** menu is used to set the brightness of the screen and to enable (or disable) this function.

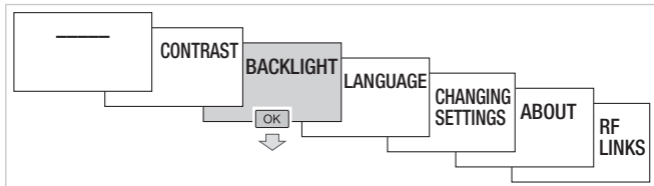

To set the backlight brightness:

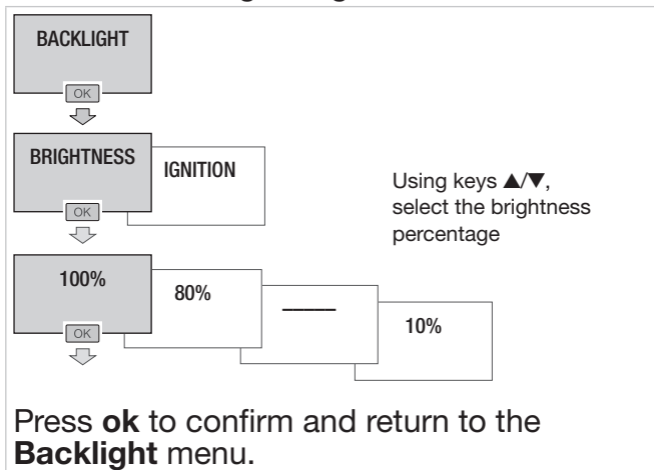

The screen backlight can be enabled temporarily or permanently.

To temporarily enable the backlight:

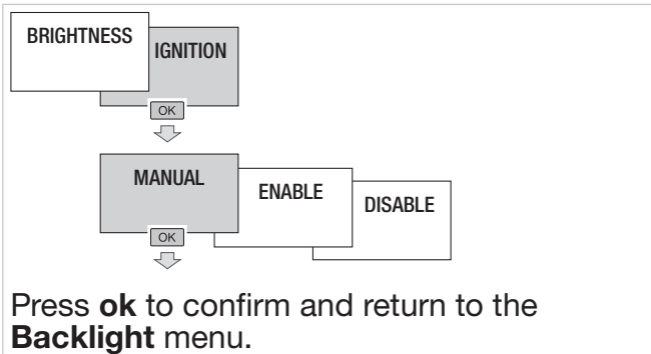

The backlight is enabled\* after pressing a key on the product and for a period of 20 s.

\* when the product is supplied with 230 V ~.

To enable the backlight permanently:

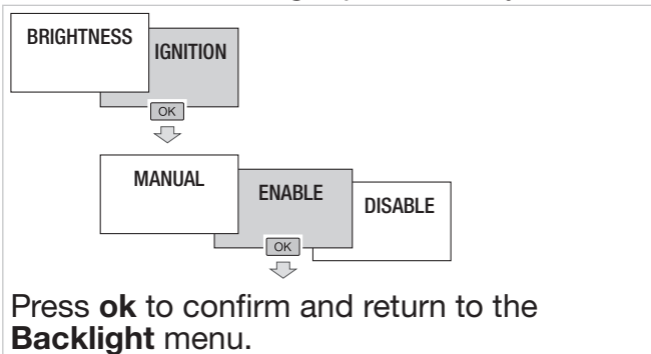

To disable the backlight:

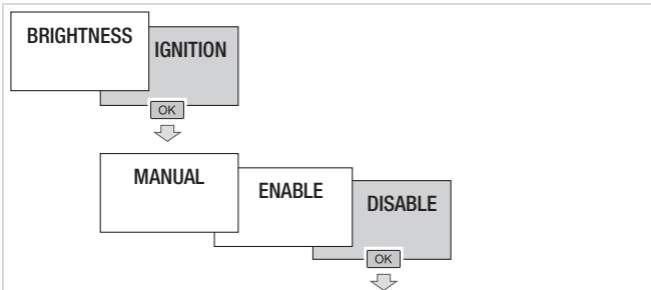

Press **ok** to confirm and return to the **Backlight** menu.

## 10.8. LANGUAGE

Select the desired language from the following: FRANÇAIS, DEUTSCH, ENGLISH, NEDERLANDS, PORTUGUES, ESPAÑOL, ITALIANA, ΕΛΛΗΝΙΚΗ, SVENSKA.

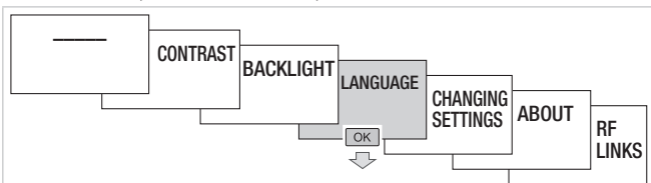

Press **ok** to confirm the language and return to the **Settings** menu.

## 10.9. CHANGING SETTINGS

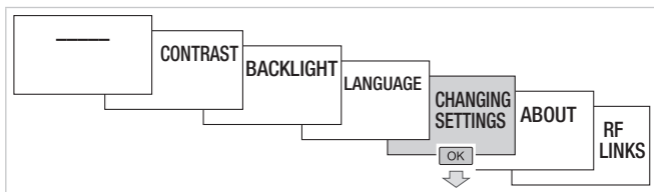

The **Changing Settings** menu has several submenus:

- Reset **BLE**: to reset the Bluetooth® link security code.



After this reset, your mobile device needs to be re-paired with your clock.

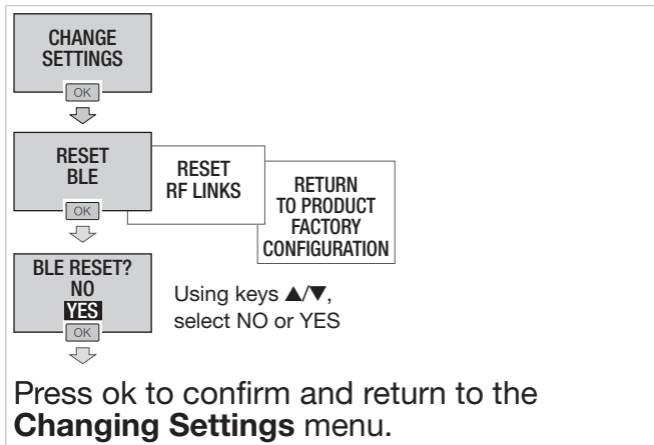

- **Reset RF links (Reset liens RF):** to delete the existing settings and RF links.

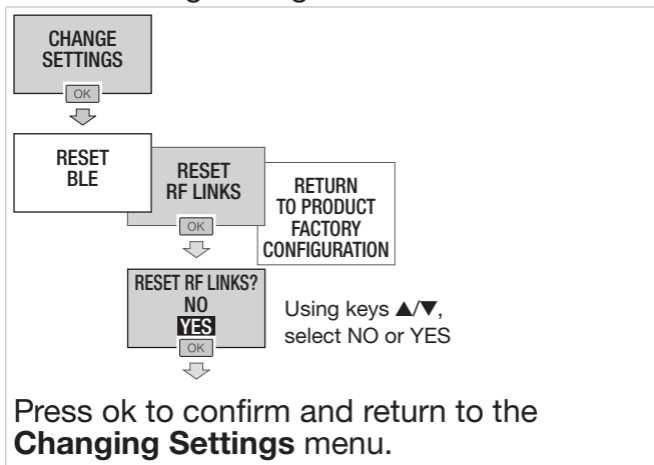

- **Return to product factory configuration:** to return to the product factory configuration, i.e. delete all programs and all settings changed.

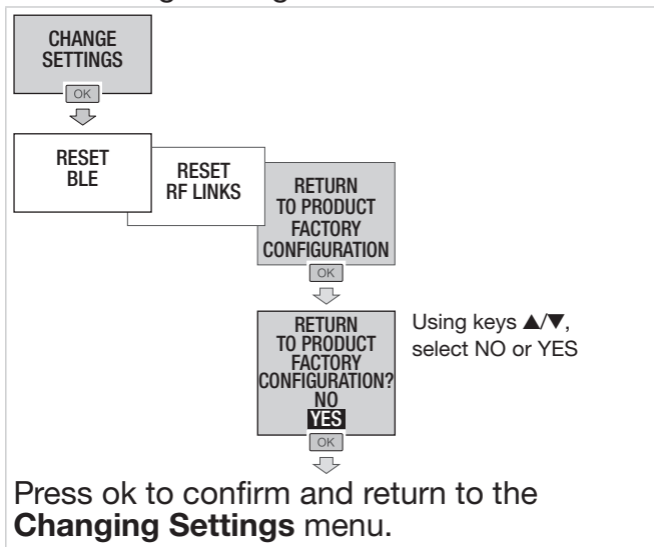

## 10.10. ABOUT

The **About** menu displays the following information:

- the product reference;
- the version of the embedded software;
- the version of the microcontroller;
- the version of the startup program;
- the unique Bluetooth® identifier seen through the mobile device / PC.

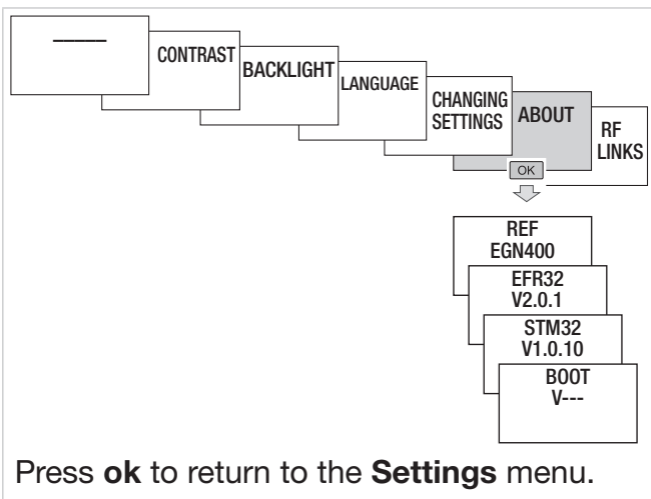

## 10.11. RF LINKS

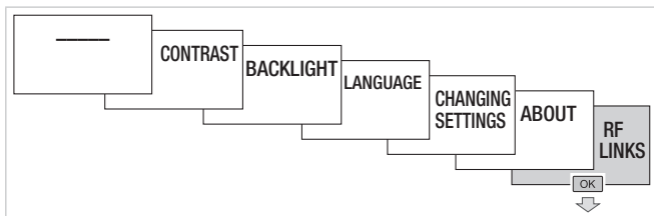

The **RF Links** menu is used to associate an output (or outputs) of the clock (receiver) with one or more Quicklink comfort products (20 or 40 transmitters depending on model) via an RF link.



This menu is accessible if a comfort product (transmitter) is in configuration mode

To associate a comfort product:

- Start the configuration procedure on the comfort product (transmitter) by pressing the **cfg** button on it;
- Select the input or the push button to configure the transmitter (for more information, see the **quicklink** configuration manual).
- Select an output available on the clock (receiver):

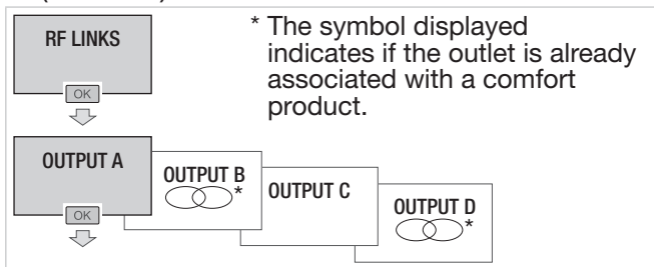

Select the function to configure:

- **No function:** deletes a function
- **Contactor:** reverses the status of the output each time it is pressed
- **ON:** enabled output
- **OFF:** disabled output
- **Scene 1:** scenario 1 function (press and hold OK to enable the scene)
- **Scene 2:** scenario 1 function (press and hold OK to enable the scene)
- **Timer ON:** output enabled for an adjustable period from 1 s to 24 h (press and hold OK to set the timer duration)



- **ON/OFF Switch:** command to enable or disable the output
- **Forcing ON:** forcing enabling of output
- **Forcing OFF:** forcing disabling of output

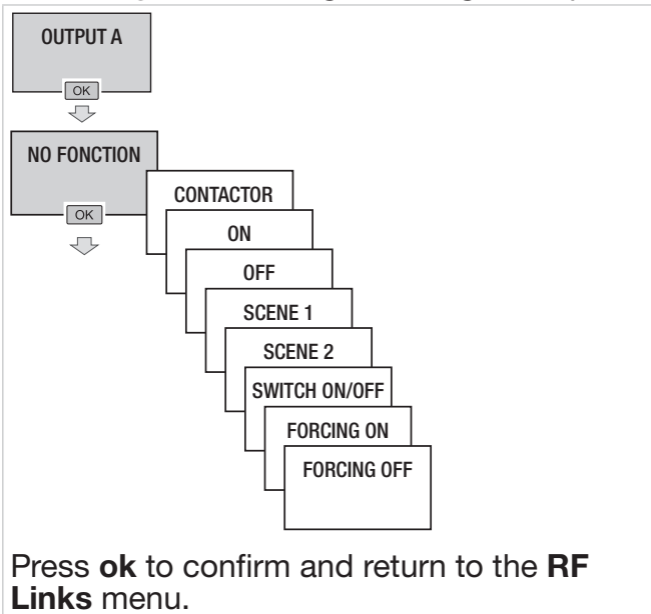

Confirm the configuration on the comfort product (transmitter) by briefly pressing the **cfg** button on it.

## 11. Update

The firmware is updated via the configuration app.

A new version of the clock firmware is offered when:

- the app is started on your mobile device;
- the mobile device and clock are connected via Bluetooth®.



## 12. Battery Failure

If the main power supply is not available and the product is running on the battery, the following message is displayed:

- if the battery level is low

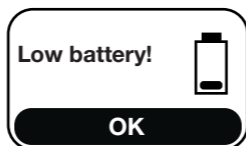

The product switches to standby mode within 5 minutes after the message is displayed if neither of the 2 keys (**OK** or **←**) is pressed.

- if the battery level is critical

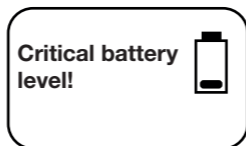



The screen turns off and the product stops working a few seconds after the message is displayed. It will no longer be possible to configure the product when it is off (screen off on battery).

Hager Controls hereby declares that this EGN200 and EGN400 time switch radio equipment complies with the essential requirements and other relevant provisions of Directive 2014/53/EU. The CE declaration may be viewed at: [www.hager.com](http://www.hager.com).



**How to dispose of this product** (electrical and electronic equipment waste). **(Applicable in European Union countries and other European countries with selective waste collection systems).**

This symbol on the product or its documentation indicates that it must not be disposed of with other household waste at the end of its life cycle. As disposing of waste inappropriately may harm the environment or human health, please separate it from other types of waste and recycle it responsibly. In this way you will contribute to the sustainable re-use of material resources.

Individuals should contact the retailer who sold them the product or contact their local council to find out where and how they can dispose of this product for recycling in an environmentally friendly manner.

Companies should contact their suppliers and read the terms of their sales contract. This product must not be disposed of with the other commercial waste.

Can be used anywhere in Europe  and Switzerland

The Bluetooth® word mark and logos are registered trademarks owned by Bluetooth SIG, Inc. and any use of such marks by Hager is under license. Other trademarks and trade names are those of their respective owners.